

S3PDB- - NXX

Three Phase Rectifier Modules

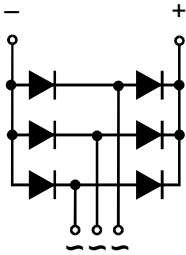
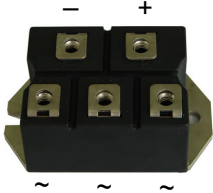

Type	V_{RSM} V	V_{RRM} V
S3PDB- - N08	900	800
S3PDB- - N12	1300	1200
S3PDB- - N14	1500	1400
S3PDB- - N16	1700	1600
S3PDB- - N18	1900	1800

Product



ul.com/rscs

Dimensions in mm (1mm=0.0394")

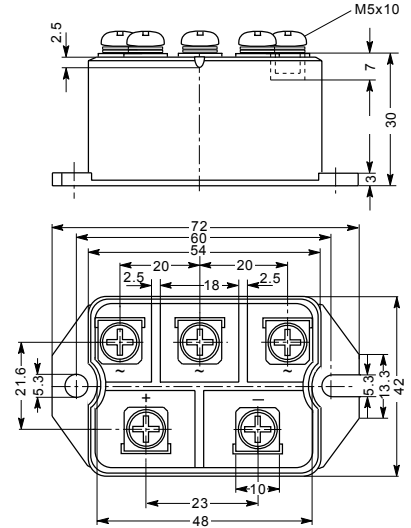

Symbol	Test Conditions	Maximum Ratings	Unit
I_{dav}	$T_C=100^{\circ}C$, module	100	A
I_{dav}	$T_A=35^{\circ}C$ ($R_{thCA}=0.2K/W$), module	91	
I_{FSM}	$T_{VJ}=45^{\circ}C$ $V_R=0$ t=10ms (50Hz), sine t=8.3ms (60Hz), sine	920 1000	A
	$T_{VJ}=T_{VJM}$ $V_R=0$ t=10ms(50Hz), sine t=8.3ms(60Hz), sine	770 850	
I^2t	$T_{VJ}=45^{\circ}C$ $V_R=0$ t=10ms (50Hz), sine t=8.3ms (60Hz), sine	5500 5500	A^2s
	$T_{VJ}=T_{VJM}$ $V_R=0$ t=10ms(50Hz), sine t=8.3ms(60Hz), sine	3800 3800	
T_{VJ} T_{VJM} T_{stg}		-40...+150 150 -40...+125	$^{\circ}C$
V_{ISOL}	50/60Hz, RMS $I_{ISOL} \leq 1mA$ t=1min t=1s	2500 3000	V~
M_d	Mounting torque (M5) Terminal connection torque (M5)	$5 \pm 15\%$ $5 \pm 15\%$	Nm
Weight	typical	160	g

Sirectifier[®]

S3PDB99NXX

Three Phase Rectifier Modules

Symbol	Test Conditions	Characteristic Values	Unit
I_R	$V_R=V_{RRM}; T_{VJ}=25^{\circ}C$ $V_R=V_{RRM}; T_{VJ}=T_{VJM}$	≤ 0.3 ≤ 5	mA
V_F	$I_F=100A; T_{VJ}=25^{\circ}C$	≤ 1.20	V
V_{TO}	For power-loss calculations only	0.8	V
r_T	$T_{VJ}=T_{VJM}$	4	$m\Omega$
R_{thJC}	per diode per module	1.40 0.23	K/W
R_{thJK}	per diode per module	1.80 0.30	K/W
d_s	Creeping distance on surface	10	mm
d_A	Creepage distance in air	9.4	mm
a	Max. allowable acceleration	50	m/s^2

FEATURES

- * Package with screw terminals
- * Isolation voltage 3000 V~
- * Glass passivated chips
- * Blocking voltage up to 1800 V
- * Low forward voltage drop
- * UL File NO.E310749
- * RoHS compliant

APPLICATIONS

- * Supplies for DC power equipment
- * Input rectifiers for PWM inverter
- * Battery DC power supplies
- * Field supply for DC motors

ADVANTAGES

- * Easy to mount with two screws
- * Space and weight savings
- * Improved temperature and power cycling



S3PDB99NXX

Three Phase Rectifier Modules

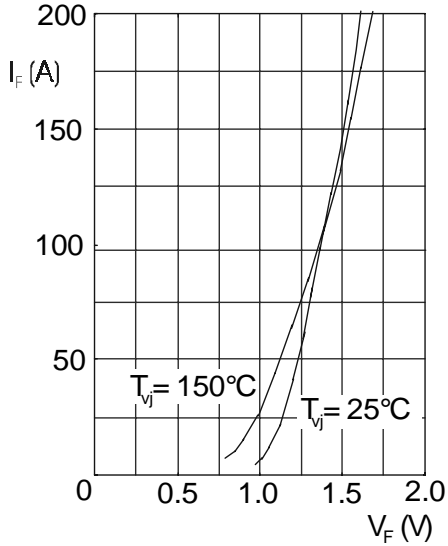

Forward current versus voltage drop per diode

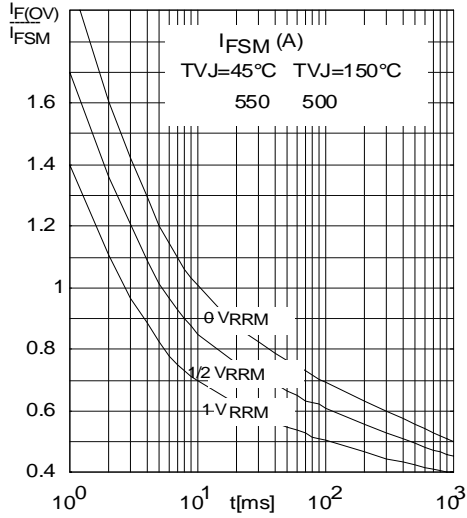

Surge overload current per diode I_{FSM} : Crest value
t: duration

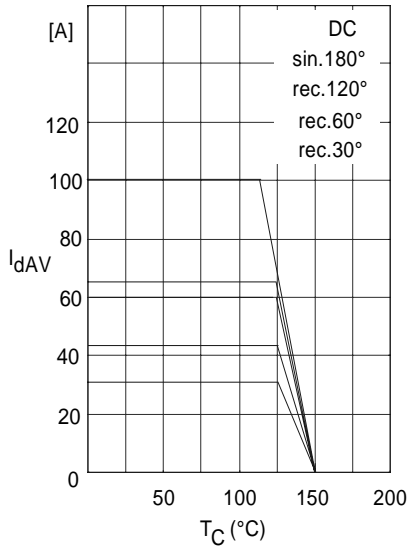

Maximum forward current at case temperature

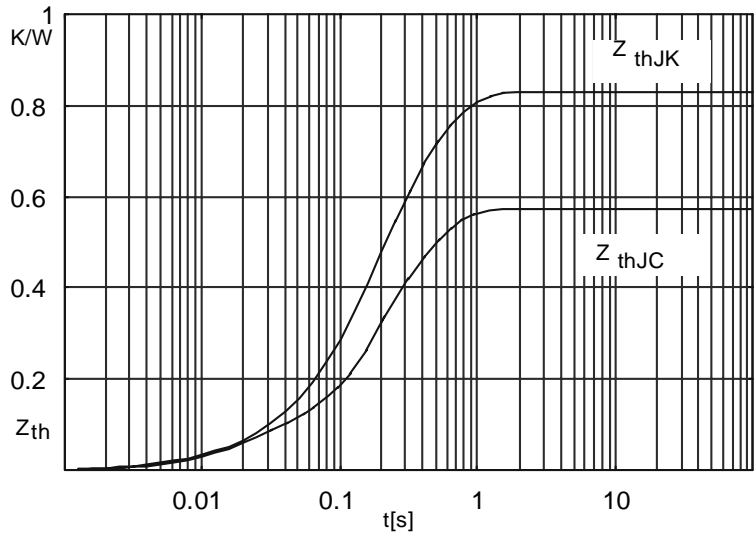

Transient thermal impedance per diode

