



Disc Diode

Rectifier Diode

SKN 6000

Features

- Capsule type metal-ceramic package with precious metal pressure contacts
- Medium voltage, high current rectifier diode with slim package for lowest thermal resistance
- Low power dissipation
- Especially suited for water cooling
- Forward selections for paralleling available

Typical Applications*

- Welding
- Electroplating

1) DSC - Double sided cooling
SSC - Single sided cooling

V_{RSM} V	V_{RRM} V	$I_{FRMS} = 10000$ A (maximum value for continuous operation) $I_{FAV} = 6000$ A (sin. 180; $T_c = 85$ °C)		
200	200	SKN 6000/02		
400	400	SKN 6000/04		
600	600	SKN 6000/06		

Symbol	Conditions	Values	Units
I_{FAV}	sin. 180; DSC ¹⁾ ; $T_c = 85$ (100) °C	6000 (5400)	A
I_{FSM}	$T_{vj} = 25$ °C; 10 ms $T_{vj} = 180$ °C; 10 ms	60000 50000	A A
i^2t	$T_{vj} = 25$ °C; 8,3 ... 10 ms $T_{vj} = 180$ °C; 8,3 ... 10 ms	18000000 12500000	A ² s A ² s
V_F	$T_{vj} = 25$ °C; $I_F = 14000$ A	max. 1,3	V
$V_{(TO)}$	$T_{vj} = 180$ °C	max. 0,7	V
r_T	$T_{vj} = 180$ °C	max. 0,04	mΩ
I_{RD}	$T_{vj} = 180$ °C; $V_{RD} = V_{RRM}$	max. 100	mA
$R_{th(j-c)}$	DSC / SSC ¹⁾	0,012 / 0,024	K/W
$R_{th(c-s)}$	DSC / SSC ¹⁾	0,005 / 0,01	K/W
T_{vj}		- 40 ... + 180	°C
T_{stg}		- 40 ... + 150	°C
V_{isol}		-	V~
F	mounting force	24 ... 30	kN
a			m/s ²
m	approx.	130	g
Case		E 35	

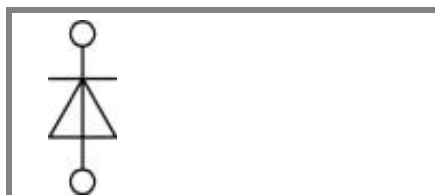

SKN

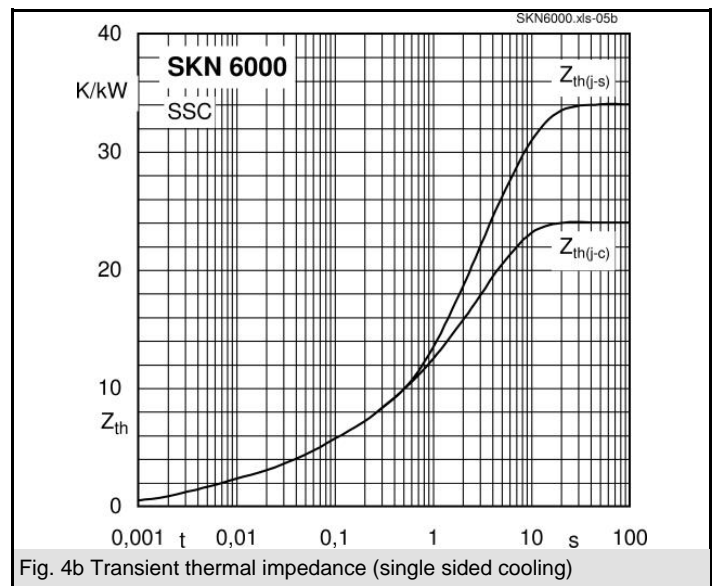
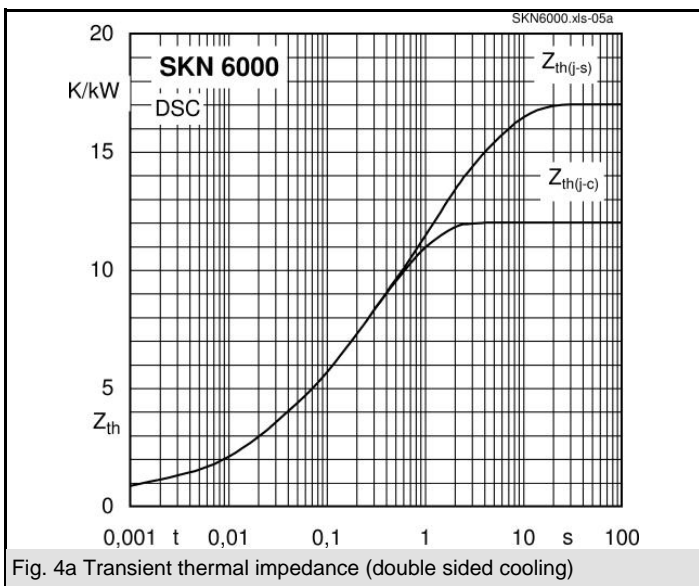
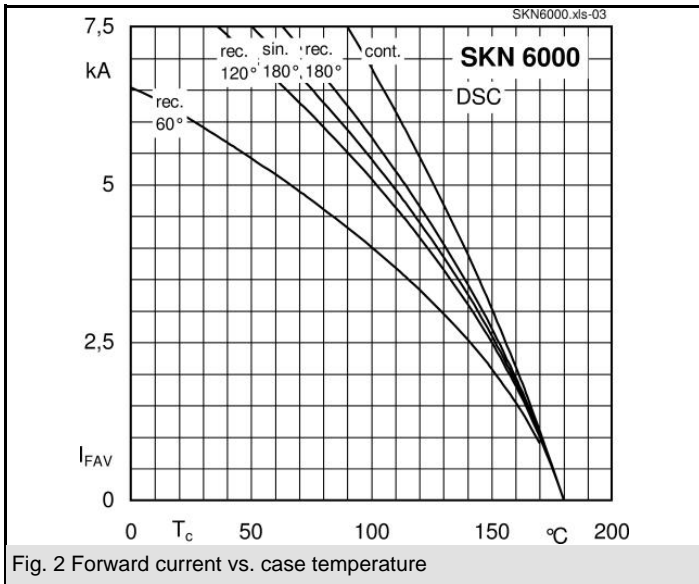
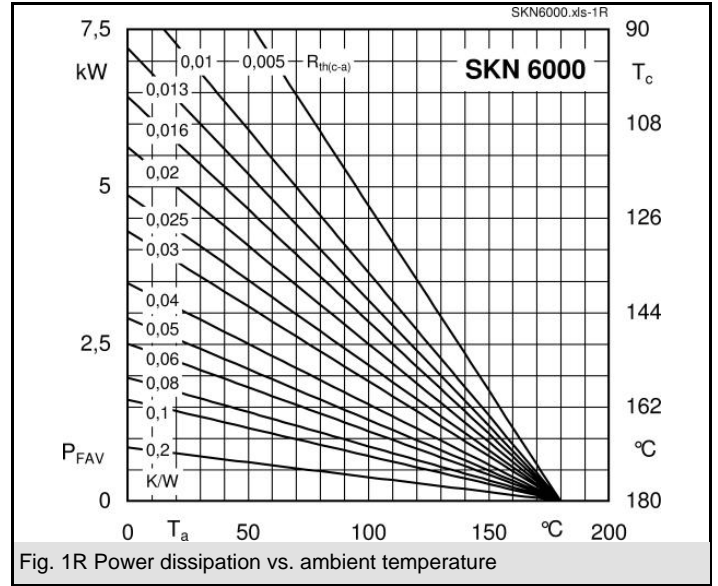
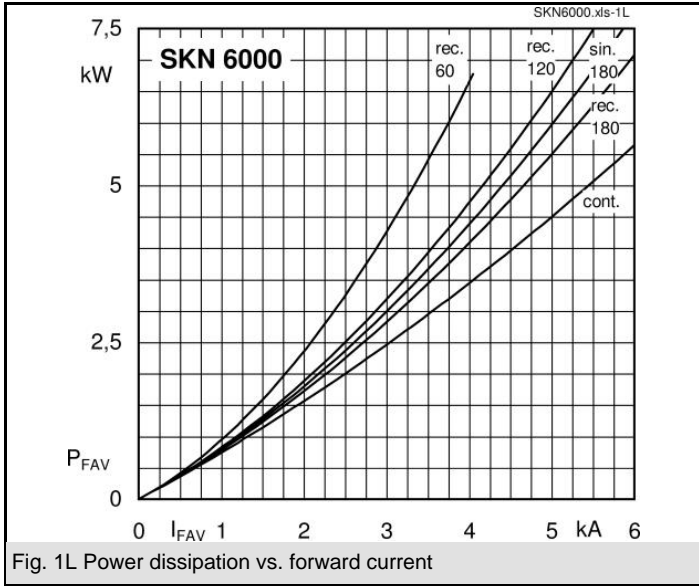

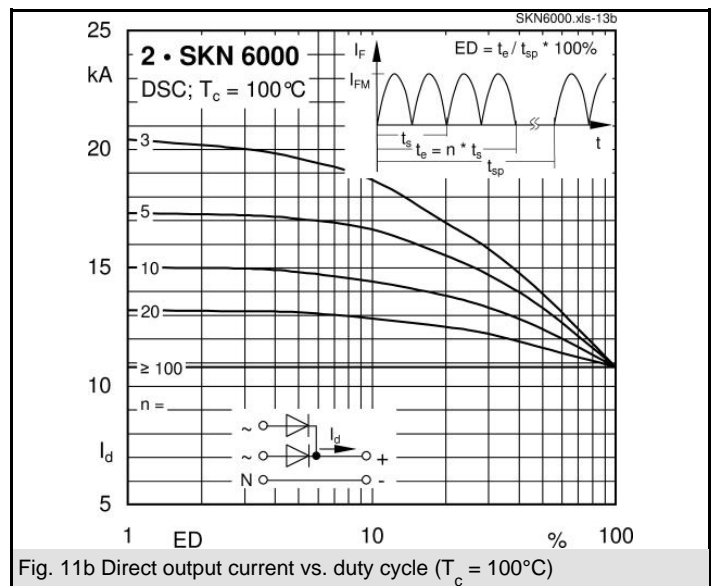
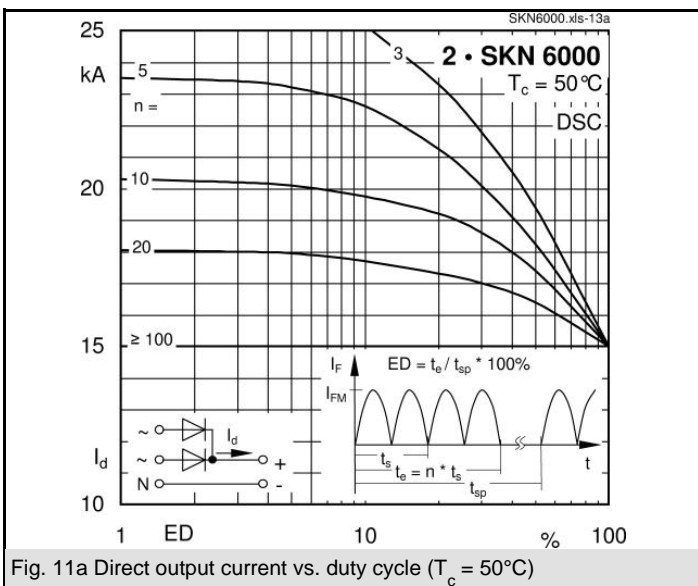
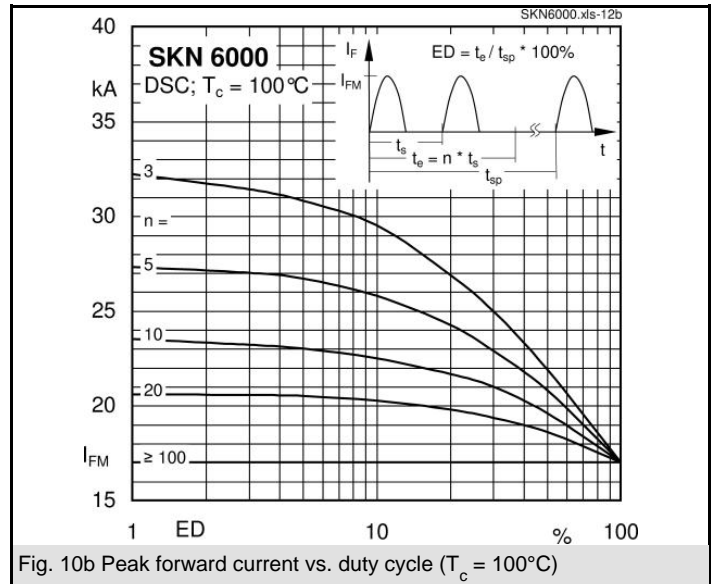
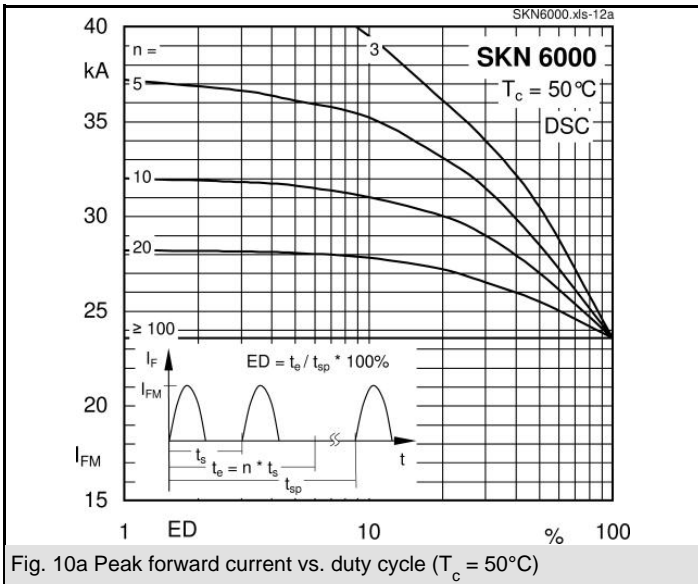
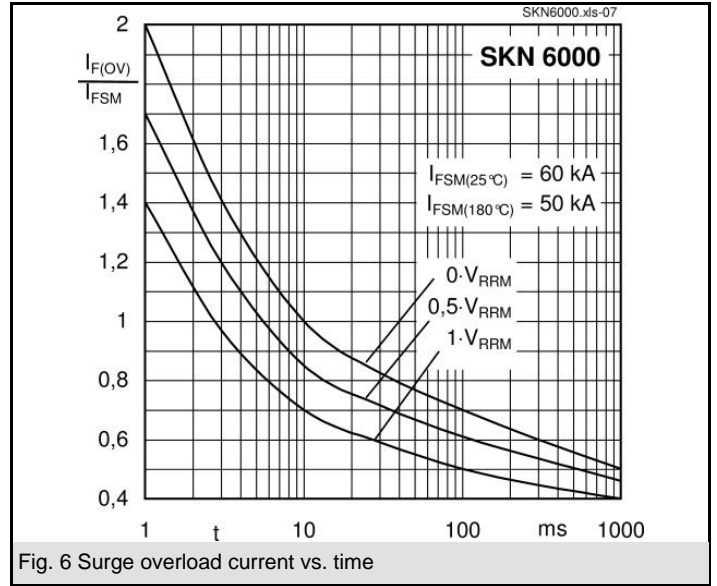
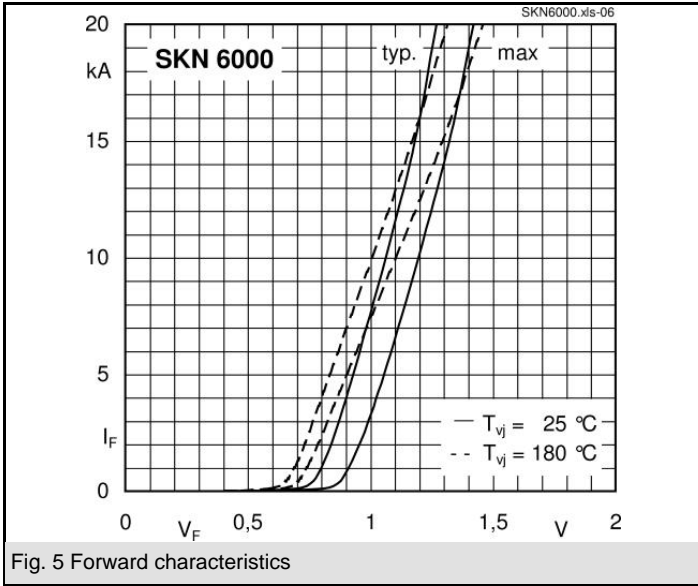

Dimensions in mm

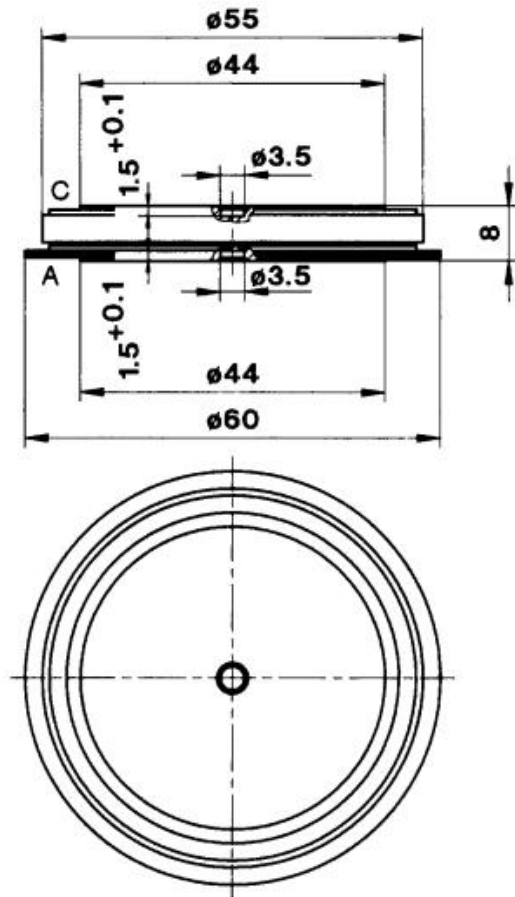

Case E 35

* The specifications of our components may not be considered as an assurance of component characteristics. Components have to be tested for the respective application. Adjustments may be necessary. The use of SEMIKRON products in life support appliances and systems is subject to prior specification and written approval by SEMIKRON. We therefore strongly recommend prior consultation of our personal.