

6-Pin General Purpose Phototransistor Optocouplers

Product Preview **4N35**

Description

The general purpose optocouplers consist of a gallium arsenide infrared emitting diode driving a silicon phototransistor in a standard plastic 6-pin dual-in-line package.

Features

- Minimum Current Transfer Ratio at $I_F = 10 \text{ mA}$, $V_{CE} = 10 \text{ V}$:
- 100% for 4N35
- Safety and Regulatory Approvals:
 - ◆ UL1577, 5,000 $V_{AC_{RMS}}$ for 1 Minute
 - ◆ DIN-EN/IEC60747-5-5, 850 V Peak Working Insulation Voltage (Pending)

Applications

- Power Supply Regulators
- Digital Logic Inputs
- Microprocessor Inputs

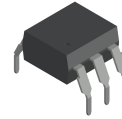

PDIP6
 M TYPE
 CASE 646CG

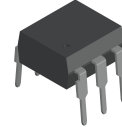

PDIP6
 STD TYPE
 CASE 646CU

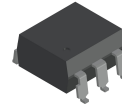

PDIP6
 S TYPE
 CASE 646CV

MARKING DIAGRAM



- ON = Logo
- 4N35 = Specific Device Code
- V = DIN EN/IEC60747-5-5 Option (only appears on component ordered with this option)
- X = One-Digit Year Code
- YY = Digit Work Week
- D = Assembly Package Code

SCHEMATIC

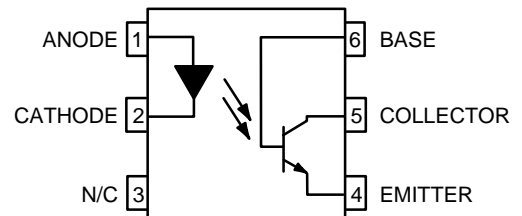

ORDERING INFORMATION

See detailed ordering and shipping information on page 7 of this data sheet.

This document contains information on a product under development. **onsemi** reserves the right to change or discontinue this product without notice.

4N35

SAFETY AND INSULATION RATINGS (As per DIN EN/IEC 60747-5-5, this optocoupler is suitable for “safe electrical insulation” only within the safety limit data. Compliance with the safety ratings shall be ensured by means of protective circuits.)

Parameter		Characteristics
Installation Classifications per DIN VDE 0110/1.89 Table 1, For Rated Mains Voltage	<150 V _{RMS}	I-IV
	<300 V _{RMS}	I-IV
Climatic Classification		55/110/21
Pollution Degree (DIN VDE 0110/1.89)		2
Comparative Tracking Index		175

Symbol	Parameter	Value	Unit
V _{PR}	Input-to-Output Test Voltage, Method A, V _{IORM} × 1.6 = V _{PR} , Type and Sample Test with t _m = 10 s, Partial Discharge < 5 pC	1360	V _{peak}
	Input-to-Output Test Voltage, Method B, V _{IORM} × 1.875 = V _{PR} , 100% Production Test with t _m = 1 s, Partial Discharge < 5 pC	1594	V _{peak}
V _{IORM}	Maximum Working Insulation Voltage	850	V _{peak}
V _{IOTM}	Highest Allowable Over-Voltage	6000	V _{peak}
	External Creepage	≥7	mm
	External Clearance	≥7	mm
	External Clearance (for Option TV, 0.4" Lead Spacing)	≥10	mm
DTI	Distance Through Insulation (Insulation Thickness)	≥0.4	mm
T _S	Case Temperature (Note 1)	175	°C
R _{IO}	Insulation Resistance at T _S , V _{IO} = 500 V (Note 1)	>10 ⁹	Ω

1. Safety limit values – maximum values allowed in the event of a failure.

ABSOLUTE MAXIMUM RATINGS

Symbol	Parameter	Max	Unit
--------	-----------	-----	------

TOTAL DEVICE

T _{STG}	Storage Temperature	-55 to +125	°C
T _{OPR}	Operating Temperature	-55 to +110	°C
T _{SOL}	Lead Solder Temperature	260 for 10 seconds	°C
P _D	Total Device Power Dissipation	200	mW

EMITTER

I _F	DC / Average Forward Input Current	50	mA
V _R	Reverse Input Voltage	6	V
P _D	LED Power Dissipation @ T _A = 25°C	70	mW
	Derate Above 100°C	3.8	mW/°C

DETECTOR

V _{CEO}	Collector-to-Emitter Voltage	80	V
V _{CBO}	Collector-to-Base Voltage	80	V
V _{ECO}	Emitter-to-Collector Voltage	7	V
P _D	Detector Power Dissipation @ T _A = 25°C	150	mW
	Derate Above 100°C	9	mW/°C

Stresses exceeding those listed in the Maximum Ratings table may damage the device. If any of these limits are exceeded, device functionality should not be assumed, damage may occur and reliability may be affected.

4N35

ELECTRICAL CHARACTERISTICS – INDIVIDUAL COMPONENT CHARACTERISTICS ($T_A = 25^\circ\text{C}$ unless otherwise noted)

Symbol	Parameter	Test Conditions	Min	Typ	Max	Unit
--------	-----------	-----------------	-----	-----	-----	------

EMITTER

V_F	Input Forward Voltage	$I_F = 10\text{ mA}$	–	1.20	1.50	V
I_R	Reverse Leakage Current	$V_R = 6.0\text{ V}$	–	–	10	μA
C_{in}	Input Capacitance	$V = 0, f = 1\text{ MHz}$	–	30	–	pF

DETECTOR

BV_{CEO}	Collector-to-Emitter Breakdown Voltage	$I_C = 1.0\text{ mA}, I_F = 0$	80	–	–	V
BV_{CBO}	Collector-to-Base Breakdown Voltage	$I_C = 0.1\text{ mA}, I_F = 0$	80	–	–	V
BV_{ECO}	Emitter-to-Collector Breakdown Voltage	$I_E = 0.1\text{ mA}, I_F = 0$	7	–	–	V
BV_{EBO}	Emitter-to-Base Breakdown Voltage	$I_E = 0.1\text{ mA}, I_F = 0$	7	–	–	V
I_{CEO}	Collector-to-Emitter Dark Current	$V_{CE} = 10\text{ V}, I_F = 0$	–	–	50	nA
I_{CBO}	Collector-to-Base Dark Current	$V_{CB} = 10\text{ V}$	–	–	20	nA
C_{CE}	Capacitance	$V_{CE} = 0\text{ V}, f = 1\text{ MHz}$	–	8	–	pF

Product parametric performance is indicated in the Electrical Characteristics for the listed test conditions, unless otherwise noted. Product performance may not be indicated by the Electrical Characteristics if operated under different conditions.

ELECTRICAL CHARACTERISTICS – TRANSFER CHARACTERISTICS ($T_A = 25^\circ\text{C}$ unless otherwise noted)

Symbol	Parameter	Test Conditions	Min	Typ	Max	Unit
--------	-----------	-----------------	-----	-----	-----	------

DC CHARACTERISTICS

CTR	Current Transfer Ratio, Collector-to-Emitter	$I_F = 10\text{ mA}, V_{CE} = 10\text{ V}$	100	–	–	%
$V_{CE(SAT)}$	Collector-to-Emitter Saturation Voltage	$I_C = 0.5\text{ mA}, I_F = 10\text{ mA}$	–	–	0.3	V

AC CHARACTERISTIC

T_{on}	Turn-on Time	$I_C = 2\text{ mA}, V_{CC} = 10\text{ V}, R_L = 100$ (Figure 11)	–	10	12	μs
T_{off}	Turn-off Time	$I_C = 2\text{ mA}, V_{CC} = 10\text{ V}, R_L = 100$ (Figure 11)	–	9	12	μs

Product parametric performance is indicated in the Electrical Characteristics for the listed test conditions, unless otherwise noted. Product performance may not be indicated by the Electrical Characteristics if operated under different conditions.

ELECTRICAL CHARACTERISTICS – ISOLATION CHARACTERISTICS ($T_A = 25^\circ\text{C}$ unless otherwise noted)

Symbol	Parameter	Test Conditions	Min	Typ	Max	Unit
V_{ISO}	Input-Output Isolation Voltage	$t = 1\text{ Minute}$	5000	–	–	$V_{AC_{RMS}}$
C_{ISO}	Isolation Capacitance	$V_{I-O} = 0\text{ V}, f = 1\text{ MHz}$	–	0.2	–	pF
R_{ISO}	Isolation Resistance	$V_{I-O} = \pm 500\text{ VDC}, T_A = 25^\circ\text{C}$	10^{11}	–	–	

Product parametric performance is indicated in the Electrical Characteristics for the listed test conditions, unless otherwise noted. Product performance may not be indicated by the Electrical Characteristics if operated under different conditions.

TYPICAL PERFORMANCE CURVES

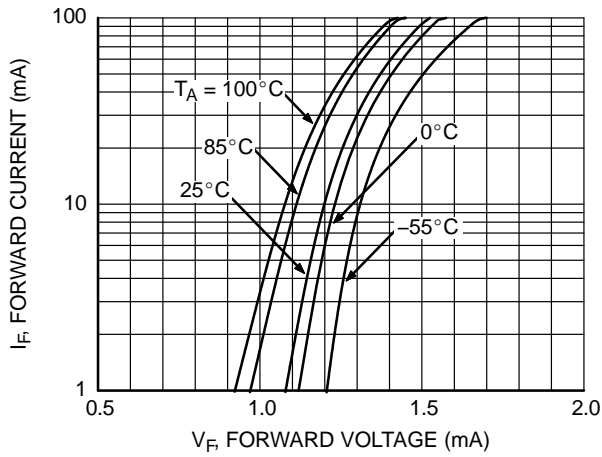

Figure 1. LED Forward Current vs. Forward Voltage

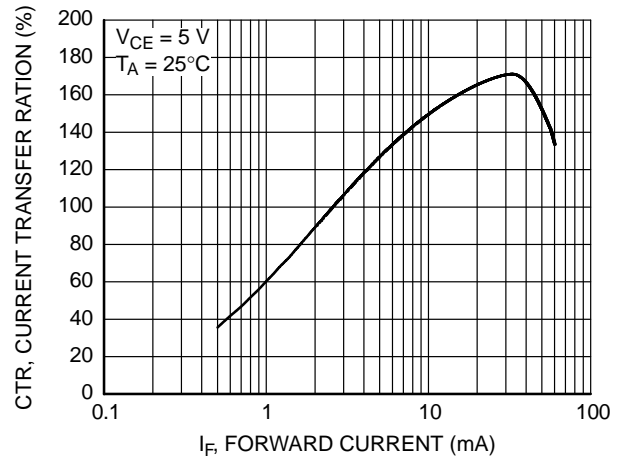

Figure 2. Current Transfer Ratio vs. Forward Current

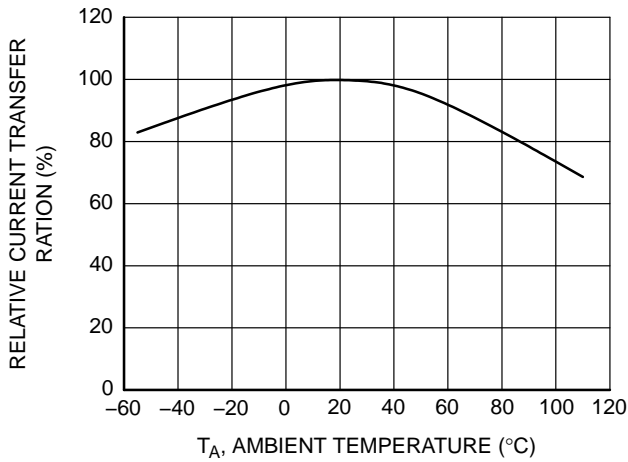

Figure 3. Relative Current Ratio vs. Ambient Temperature

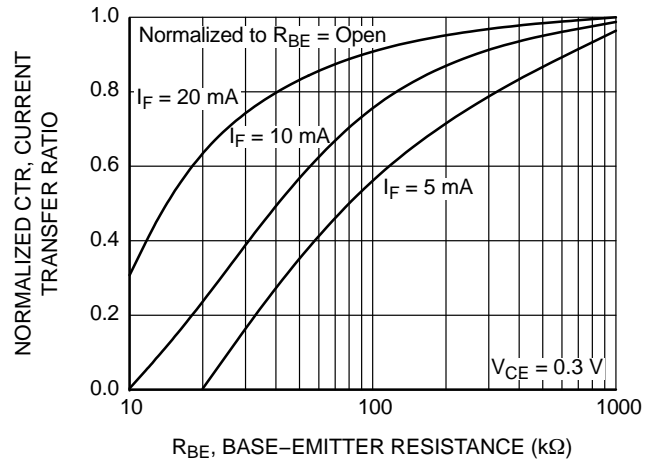

Figure 4. Current Transfer Ratio (Saturated) vs. Base-Emitter Resistance

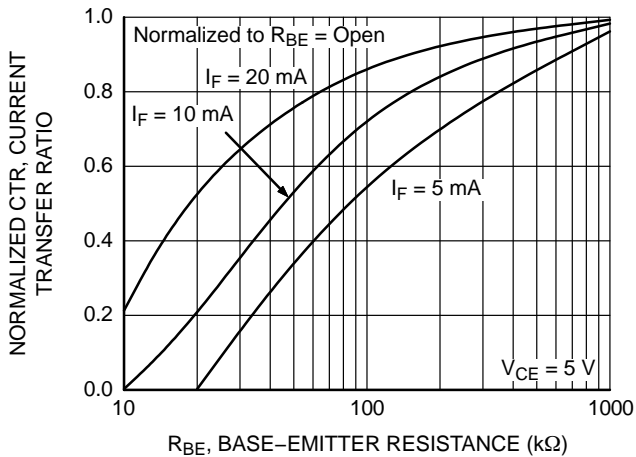

Figure 5. Current Transfer Ratio (Unsatuated) vs. Base-Emitter Resistance

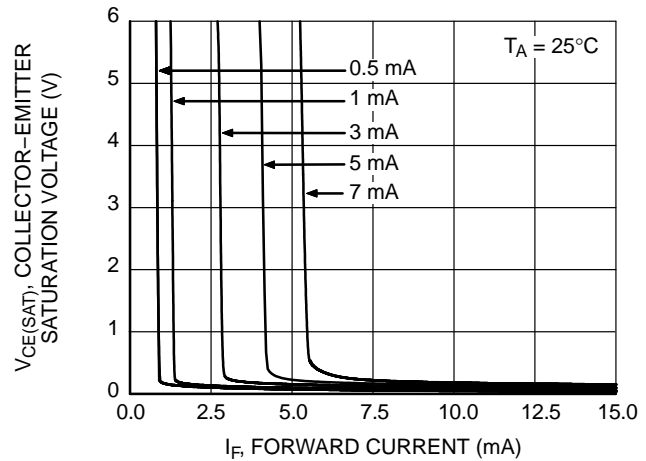

Figure 6. Collector-Emitter Saturation Voltage vs. Forward Current

TYPICAL PERFORMANCE CURVES (continued)

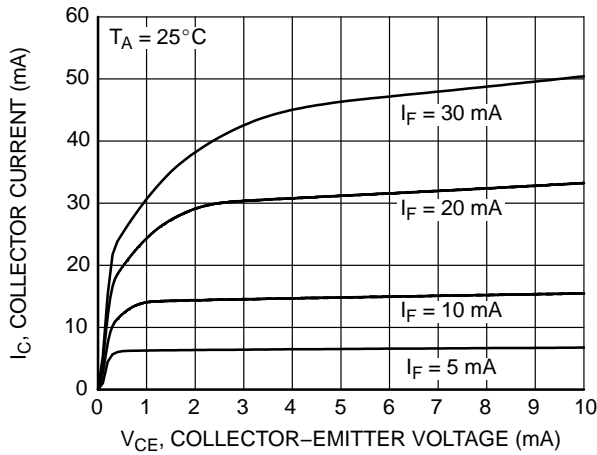

Figure 7. Collector Current vs. Collector-Emitter Voltage

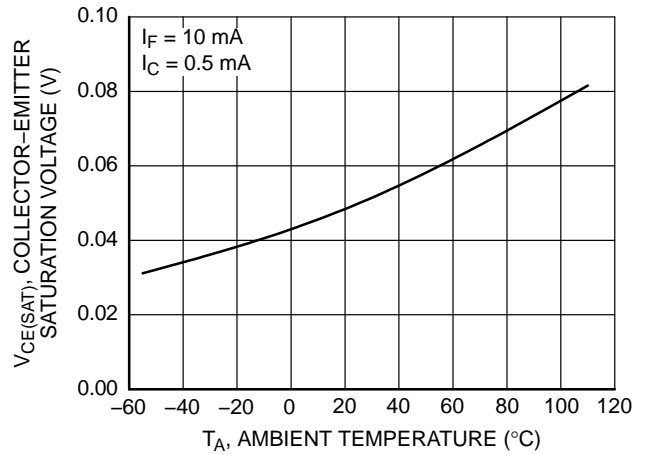

Figure 8. Collector-Emitter Saturation Voltage vs. Ambient Temperature

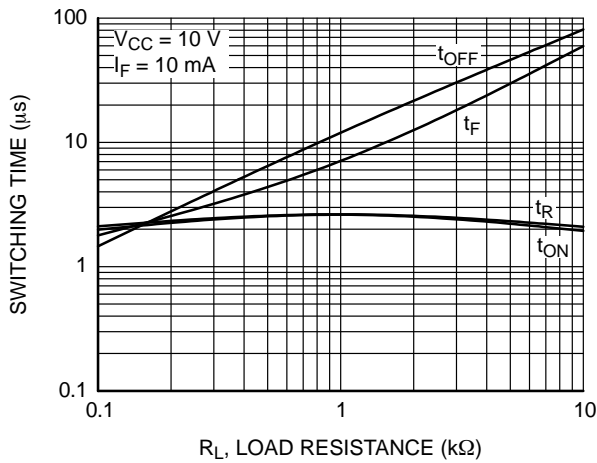

Figure 9. Switching Time vs. Load Resistance

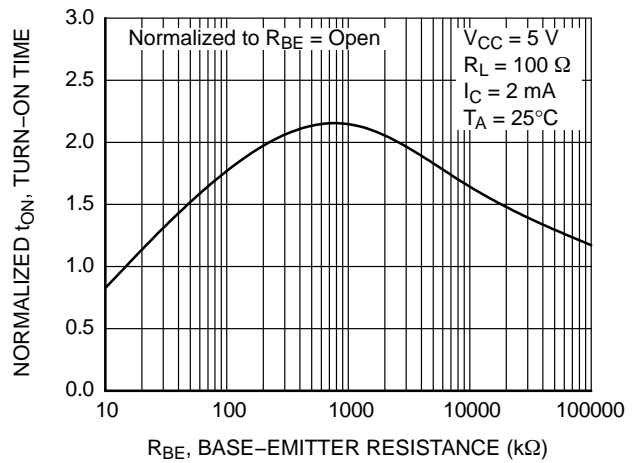

Figure 10. Turn-on Time vs. Base-Emitter Resistance

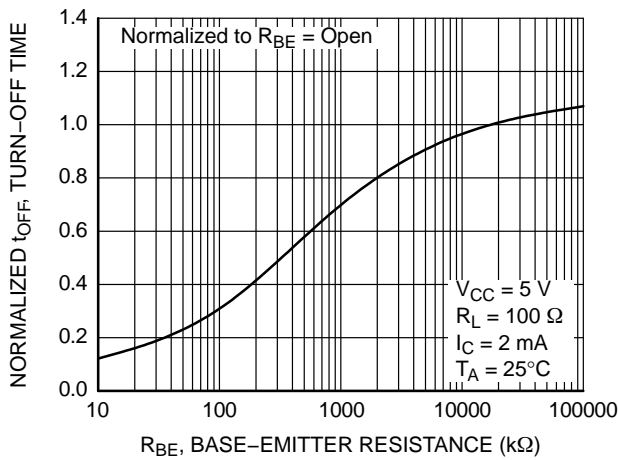

Figure 11. Turn-off Time vs. Base-Emitter Resistance

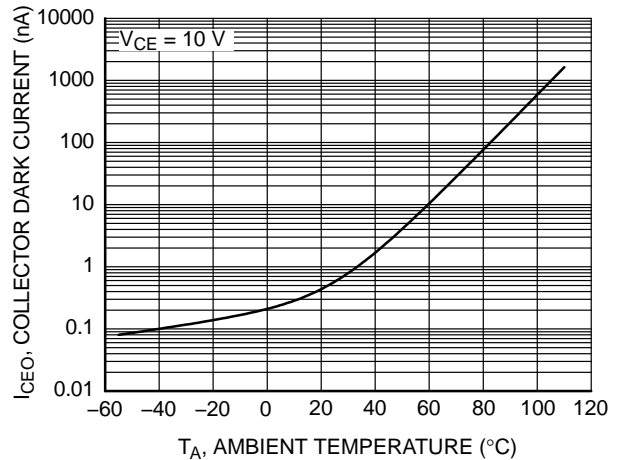

Figure 12. Collector Dark Current vs. Ambient Temperature

TYPICAL PERFORMANCE CURVES (continued)

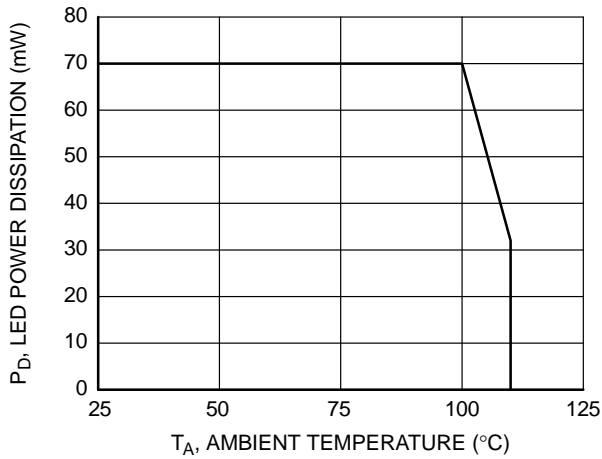

Figure 13. Max Allowable Power Dissipation (LED) vs. Ambient Temperature

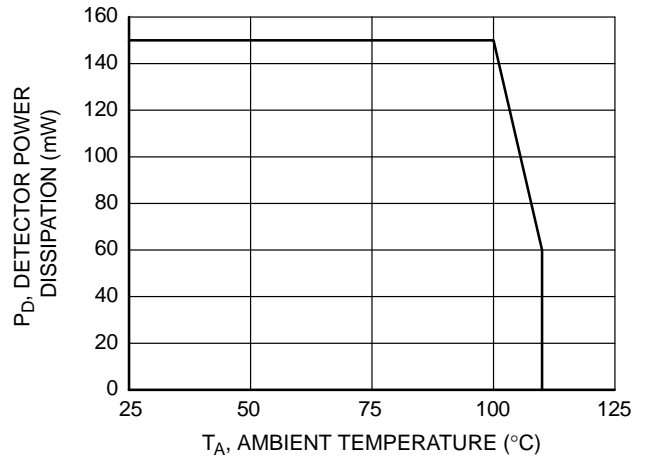

Figure 14. Max Allowable Power Dissipation (Detector) vs. Ambient Temperature

SWITCHING TIME TEST CIRCUIT AND WAVEFORMS

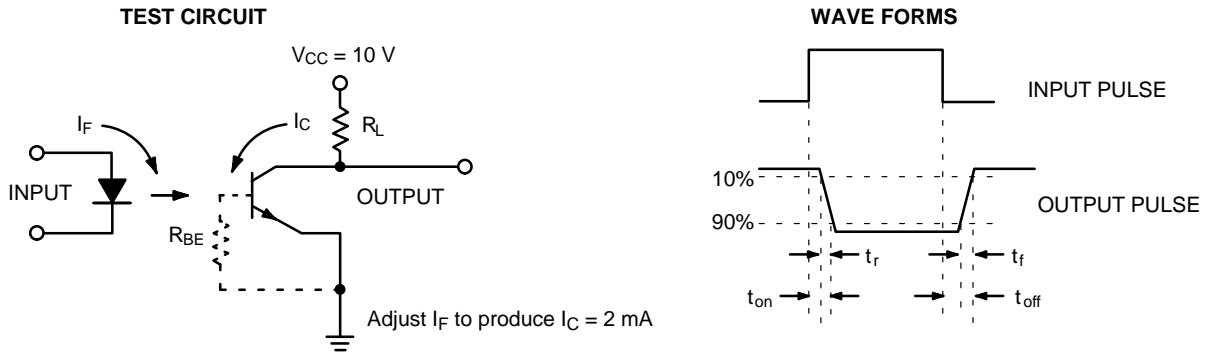
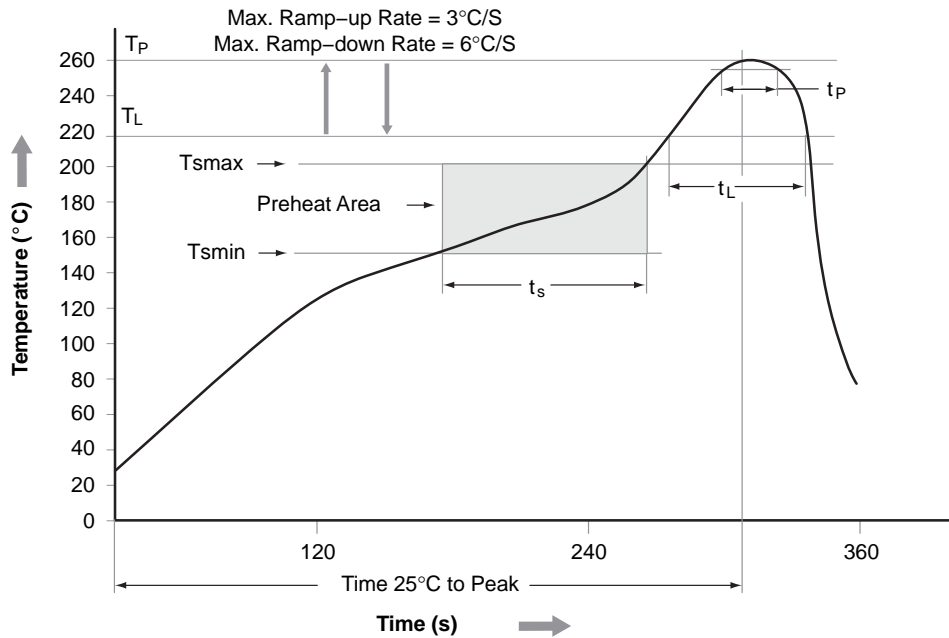

Figure 15. Switching Time Test Circuit and Waveform

4N35

REFLOW PROFILE



Profile Feature	Pb-Free Assembly Profile
Temperature Min. (T_{smin})	150°C
Temperature Max. (T_{smax})	200°C
Time (t_s) from (T_{smin} to T_{smax})	60–120 seconds
Ramp-up Rate (t_L to t_p)	3°C/second max.
Liquidous Temperature (T_L)	217°C
Time (t_L) Maintained Above (T_L)	60 – 150 seconds
Peak Body Package Temperature	260°C +0°C / -5°C
Time (t_p) within 5°C of 260°C	30 seconds
Ramp-down Rate (T_P to T_L)	6°C/second max.
Time 25°C to Peak Temperature	8 minutes max.

Figure 16. Reflow Profile

ORDERING INFORMATION

Part Number	Package	Shipping†
4N35	DIP 6-Pin	65 Units / Tube
4N35SR2	SMT 6-Pin (Lead Bend)	1000 Units / Tape & Reel
4N35SR2V	SMT 6-Pin (Lead Bend), DIN EN/IEC60747-5-5 Option	1000 Units / Tape & Reel
4N35TV	DIP 6-Pin, 0.4" Lead Spacing, DIN EN/IEC60747-5-5 Option	65 Units / Tube

†For information on tape and reel specifications, including part orientation and tape sizes, please refer to our Tape and Reel Packaging Specifications Brochure, BRD8011/D.

4N35

PACKAGE DIMENSIONS

PDIP6 7.12x6.50, 2.54P (M TYPE)
CASE 646CG
ISSUE O

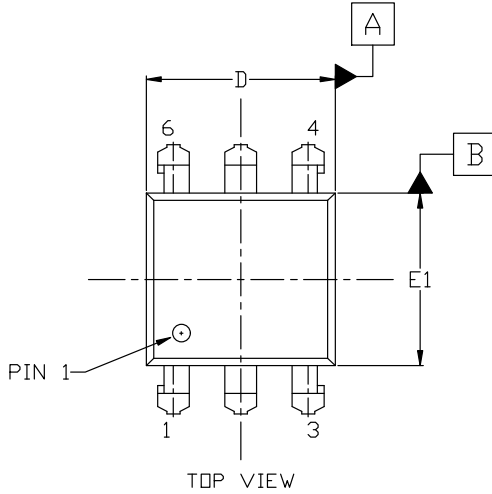

NOTES:

- A) NO STANDARD APPLIES TO THIS PACKAGE.
- B) ALL DIMENSIONS ARE IN MILLIMETERS.
- C) DIMENSIONS ARE EXCLUSIVE OF BURRS, MOLD FLASH, AND TIE BAR EXTRUSION
- D) DRAWING FILENAME AND REVISION: MKT-N06Drev4

DIM	MILLIMETERS		
	MIN.	NOM.	MAX.
A	4.20	4.50	4.80
b	0.40	0.50	0.60
b1	1.10	1.20	1.30
b2	0.24	0.25	0.26
c	0.25 REF		
D	6.82	7.12	7.32
E	7.62 TYP		
E1	6.20	6.50	6.80
E2	10.16 TYP		
e	2.54 TYP		

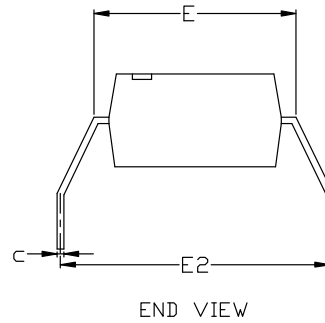
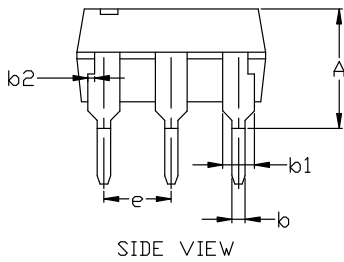

4N35

PACKAGE DIMENSIONS

PDIP6 7.12x6.50, 2.54P (STD TYPE)
CASE 646CU
ISSUE O

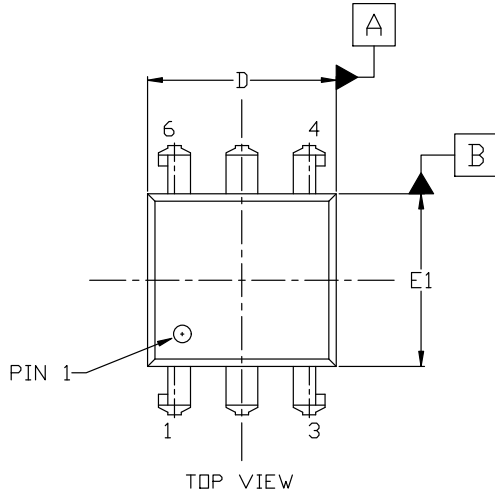

NOTES:

- A) NO STANDARD APPLIES TO THIS PACKAGE.
- B) ALL DIMENSIONS ARE IN MILLIMETERS.
- C) DIMENSIONS ARE EXCLUSIVE OF BURRS, MOLD FLASH, AND TIE BAR EXTRUSION

DIM	MILLIMETERS		
	MIN.	NOM.	MAX.
A	4.20	4.50	4.80
A1	2.30	2.80	3.30
b	0.40	0.50	0.60
b1	1.10	1.20	1.30
b2	0.34	0.35	0.36
c	0.25 REF		
D	6.82	7.12	7.32
E	7.62 TYP		
E1	6.20	6.50	6.80
E2	7.62	---	9.50
e	2.54 TYP		

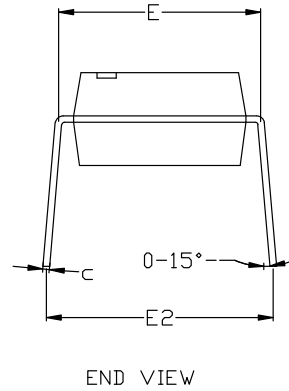
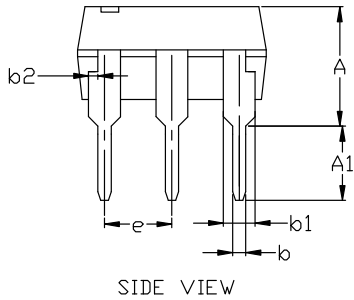

4N35

PACKAGE DIMENSIONS

PDIP6 7.12x6.50, 2.54P (S TYPE) CASE 646CV ISSUE O

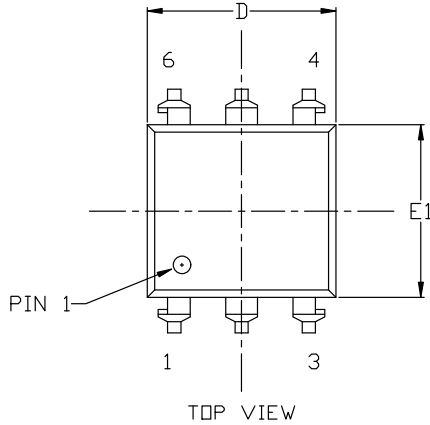

NOTES:

- A) NO STANDARD APPLIES TO THIS PACKAGE.
- B) ALL DIMENSIONS ARE IN MILLIMETERS.
- C) DIMENSIONS ARE EXCLUSIVE OF BURRS, MOLD FLASH, AND TIE BAR EXTRUSION

DIM	MILLIMETERS		
	MIN.	NOM.	MAX.
A	4.00	4.30	4.60
A2	3.20	3.50	3.80
b	0.40	0.50	0.60
b1	1.10	1.20	1.30
c	0.25 REF		
D	6.82	7.12	7.32
E	7.62 TYP		
E1	6.20	6.50	6.80
E2	8.00	---	---
E3	---	---	10.3
e	2.54 TYP		

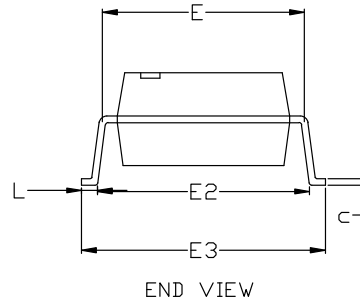
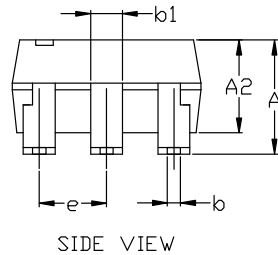

onsemi, Onsemi, and other names, marks, and brands are registered and/or common law trademarks of Semiconductor Components Industries, LLC dba "onsemi" or its affiliates and/or subsidiaries in the United States and/or other countries. onsemi owns the rights to a number of patents, trademarks, copyrights, trade secrets, and other intellectual property. A listing of onsemi's product/patent coverage may be accessed at www.onsemi.com/site/pdf/Patent-Marketing.pdf. onsemi reserves the right to make changes at any time to any products or information herein, without notice. The information herein is provided "as-is" and onsemi makes no warranty, representation or guarantee regarding the accuracy of the information, product features, availability, functionality, or suitability of its products for any particular purpose, nor does onsemi assume any liability arising out of the application or use of any product or circuit, and specifically disclaims any and all liability, including without limitation special, consequential or incidental damages. Buyer is responsible for its products and applications using onsemi products, including compliance with all laws, regulations and safety requirements or standards, regardless of any support or applications information provided by onsemi. "Typical" parameters which may be provided in onsemi data sheets and/or specifications can and do vary in different applications and actual performance may vary over time. All operating parameters, including "Typicals" must be validated for each customer application by customer's technical experts. onsemi does not convey any license under any of its intellectual property rights nor the rights of others. onsemi products are not designed, intended, or authorized for use as a critical component in life support systems or any FDA Class 3 medical devices or medical devices with a same or similar classification in a foreign jurisdiction or any devices intended for implantation in the human body. Should Buyer purchase or use onsemi products for any such unintended or unauthorized application, Buyer shall indemnify and hold onsemi and its officers, employees, subsidiaries, affiliates, and distributors harmless against all claims, costs, damages, and expenses, and reasonable attorney fees arising out of, directly or indirectly, any claim of personal injury or death associated with such unintended or unauthorized use, even if such claim alleges that onsemi was negligent regarding the design or manufacture of the part. onsemi is an Equal Opportunity/Affirmative Action Employer. This literature is subject to all applicable copyright laws and is not for resale in any manner.

PUBLICATION ORDERING INFORMATION

LITERATURE FULFILLMENT:
Email Requests to: orderlit@onsemi.com

onsemi Website: www.onsemi.com

TECHNICAL SUPPORT
North American Technical Support:
Voice Mail: 1 800-282-9855 Toll Free USA/Canada
Phone: 011 421 33 790 2910

Europe, Middle East and Africa Technical Support:
Phone: 00421 33 790 2910
For additional information, please contact your local Sales Representative