

Power Relay G6RN

Heavy-duty Miniature Relay

- Incorporates environmentally-friendly, cadmium-free contacts.
- Variety of contact forms: SPDT or SPST-NO (continuous current rating: 8 A).
- Low profile (0.39 W x 1.12 L x 0.59 H inches)
- High dielectric strength of 4 kV with 8 mm creepage/clearance.
- Sealed plastic construction.
- Ideal for switching contactors, solenoids and motors.
- RoHS Compliant.



Ordering Information

Classification	Structure	Contact material	Contact form	
			SPST-NO	SPDT
Standard	Plastic-sealed	Ag-Alloy + gold plating	G6RN-1A	G6RN-1

Note: When ordering, add the rated coil voltage to the model number.

Example: G6RN-1A DC24
Rated coil voltage

Model Number Legend

G6RN- - DC
1 2 3

1. Number of Poles

1: 1 pole

2. Contact Form

None: SPDT

A: SPST-NO

3. Rated Coil Voltage

5, 12, 24, 48

Specifications

Coil Ratings

Rated voltage	5 VDC	12 VDC	24 VDC	48 VDC
Rated current	43.9 mA	18.3 mA	9.2 mA	5.2 mA
Coil resistance	114 Ω	655 Ω	2,620 Ω	9,210 Ω
Must operate voltage	70% max. of rated voltage			
Must release voltage	10% min. of rated voltage			
Max. voltage	110% of rated voltage			
Power consumption	Approx. 220 mW			Approx. 250 mW

Note: 1. The rated current and coil resistance are measured at a coil temperature of 23°C with a tolerance of ±10%.

2. Operating characteristics are measured at a coil temperature of 23°C.

■ Contact Ratings

Contact material	Ag-Alloy + gold plating (standard)
Rated switching current (resistive)	8 A at 250 VAC 5 A at 30 VDC
Rated carry current	8A
Max. switching voltage	250 VAC, 30 VDC
Max. switching capacity	2,000 VA, 150 W
Min. permissible load	10 mA, 5 VDC

Note: P level: $\lambda_{60} = 0.1 \times 10^{-6}$ operation

■ Characteristics

Contact resistance	100 mΩ max.	
Operate time	Approx. 6 ms	
Release time	Approx. 3 ms	
Max. operating frequency	Mechanical	36,000 operations/hr
	Electrical	360 operations/hr (under rated load)
Insulation resistance	1,000 MΩ min.	
Dielectric strength	4,000 VAC: between coil and contacts	
	1,000 VAC: between contacts	
Creepage/clearance	8 mm min. between coil and contacts	
Vibration resistance	Malfunction	NO: 10 to 55 Hz, 1.5 mm double amplitude
		NC: 10 to 55 Hz, 0.8 mm double amplitude
Shock resistance	Destruction	1,000 m/s ² (approx. 100 G)
	Malfunction	NO: 100 m/s ² (approx. 10 G) NC: 50 m/s ² (approx. 5 G)
Life expectancy	Mechanical	10,000,000 operations min.
	Electrical	50,000 operations (Typ. 100,000 operations - see note)
Ambient temperature	Operating	-40°C to 85°C
	Storage	-40°C to 85°C
Ambient humidity	Operating	5% to 85%
Weight	Approx. 9 g	
Protection class	II according to VDE0106 Part 1	
Insulation class	C/250, B/380 according to VDE0110	

Note: Resistive load test at 250 VAC, 8 A, room temperature with diode.
Continuous monitoring must be performed to detect contact sticking and short circuit.
Dielectric strength measured at 500 V for 1 minute with the same polarity.

■ Approved Standards

VDE (EN61810-1)

Contact form	Coil ratings	Contact ratings
SPDT SPST-NO	5, 12, 24, 48 VDC	8 A at 250 VAC (cosφ =1)

UL Recognized (File No. E41515) /CSA Certified (File No. LR31928-543) - - Ambient Temp. = 40°C

Coil ratings	Contact ratings
5, 12, 24, 48 VDC	250 VAC, 10 A resistive 250 VAC, 8 A resistive, 85°C 30 VDC, 5 A resistive

Engineering Data

Maximum Switching Power

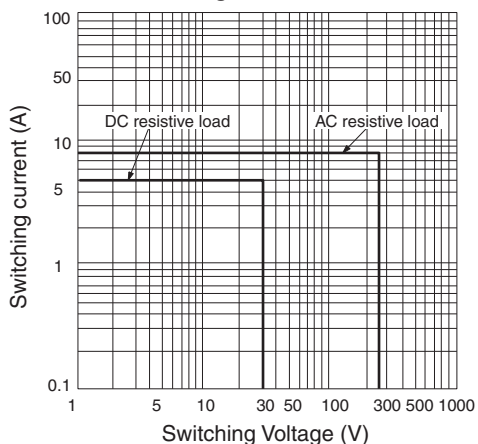

Endurance

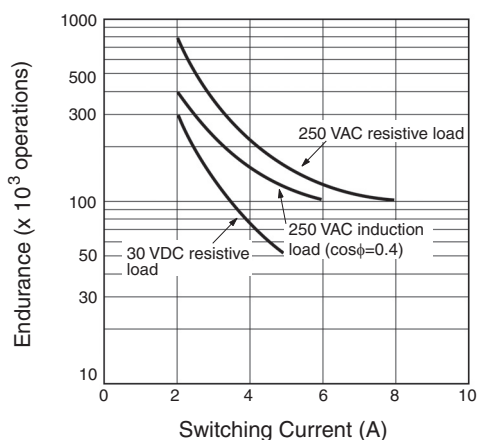

Ambient Temperature vs Maximum Coil Voltage

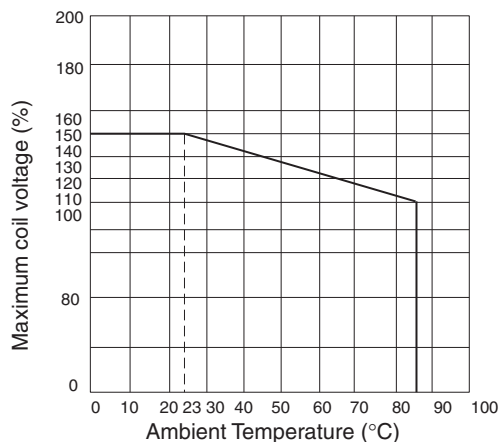

Note: The maximum coil voltage refers to the maximum value in a varying range of operating power voltage, not a continuous voltage.

Dimensions

Unit: mm

■ SPDT Type

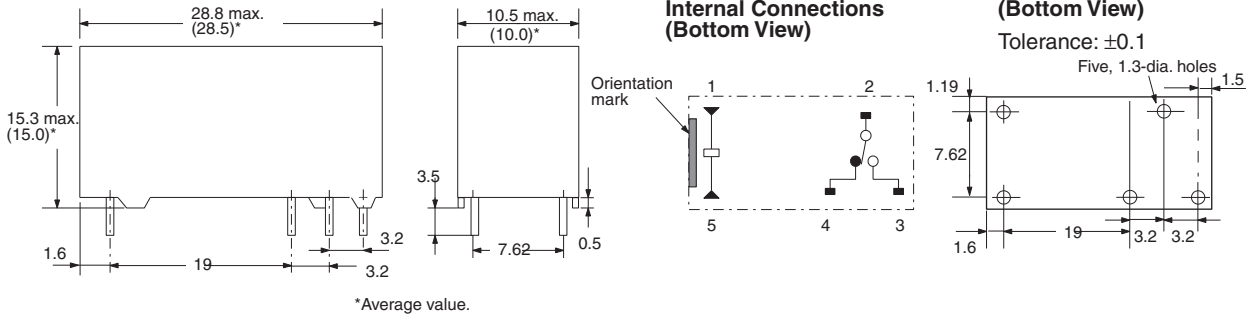
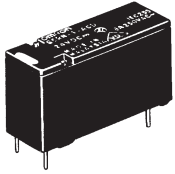

■ SPST-NO Type

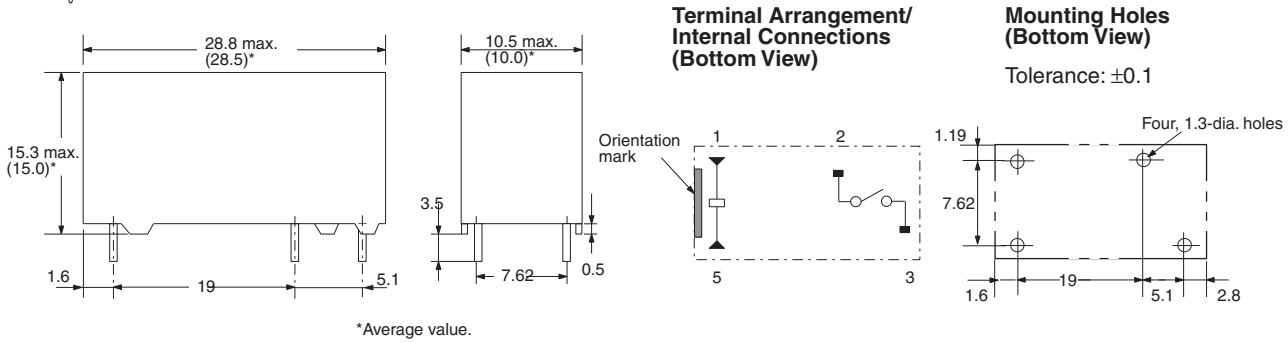
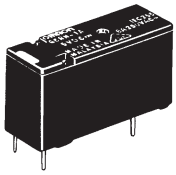

A large grid of 20 columns and 30 rows of small squares, used for taking notes or drawing diagrams. The grid is composed of thin, light gray lines forming a uniform pattern across the page.

All sales are subject to Omron Electronic Components LLC standard terms and conditions of sale, which can be found at http://www.components.omron.com/components/web/webfiles.nsf/sales_terms.html

ALL DIMENSIONS SHOWN ARE IN MILLIMETERS.
To convert millimeters into inches, multiply by 0.03937. To convert grams into ounces, multiply by 0.03527.

OMRON[®]

**OMRON ELECTRONIC
COMPONENTS LLC**

55 E. Commerce Drive, Suite B
Schaumburg, IL 60173

847-882-2288

OMRON ON-LINE

Global - <http://www.omron.com>

USA - <http://www.components.omron.com>

Cat. No. X301-E-1b

09/11

Specifications subject to change without notice

Printed in USA